

MONTÁŽNY NÁVOD

MODUL 6DV

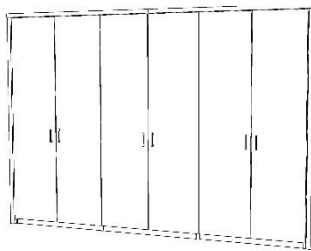

- 1** Skôr ako začneme montovať si roztriedime bočnice a strednicu skrine. Strednica má predvŕtané diery skrz. Do predvŕtaných otvorov bočnice skrine naskrutkujeme „ťahlo jednostranné“ a vložíme drevené kolíky. Do strednice namontujeme „ťahlo obojstranné“ a vložíme kolíky z oboch strán.



ťahlo jednostranné



ťahlo obojstranné



drevený kolík

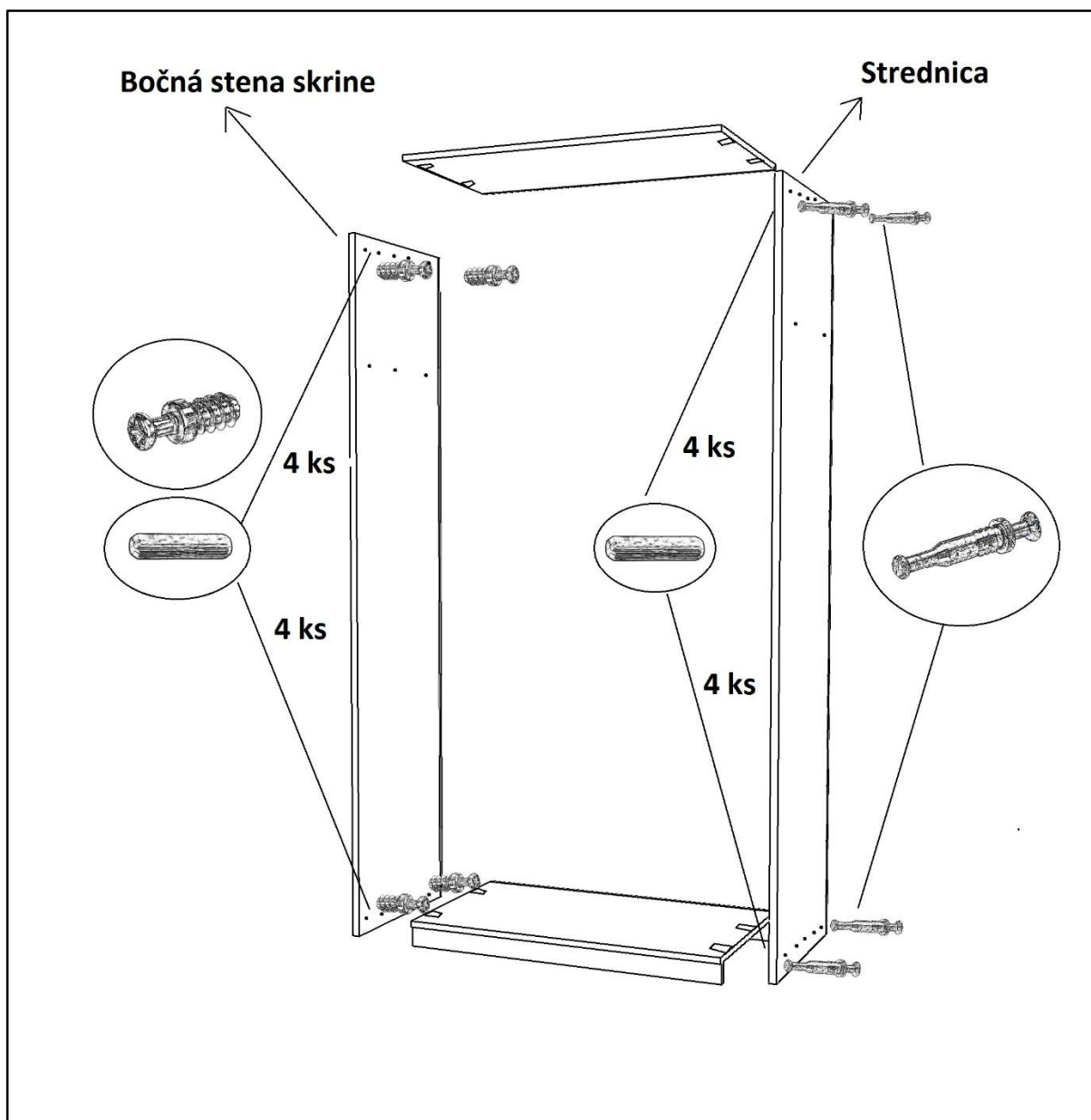

- 2** Bočnicu spojíme so spodným soklom zatahnutím excentrov. Vložíme zadný sololit do drážky, priložíme strednicu a zatahneme excentre. Nasadíme vrchný top skrine a zatahneme excentre. Do zadného sololitu vložíme spojku a priskrutkujeme skrutkou 4/16 s pologuľatou hlavou pritiahneme sololit a poistíme proti posunutiu samoreznou skrutkou 4/16..



spojka



samorezná skrutka 4/16mm

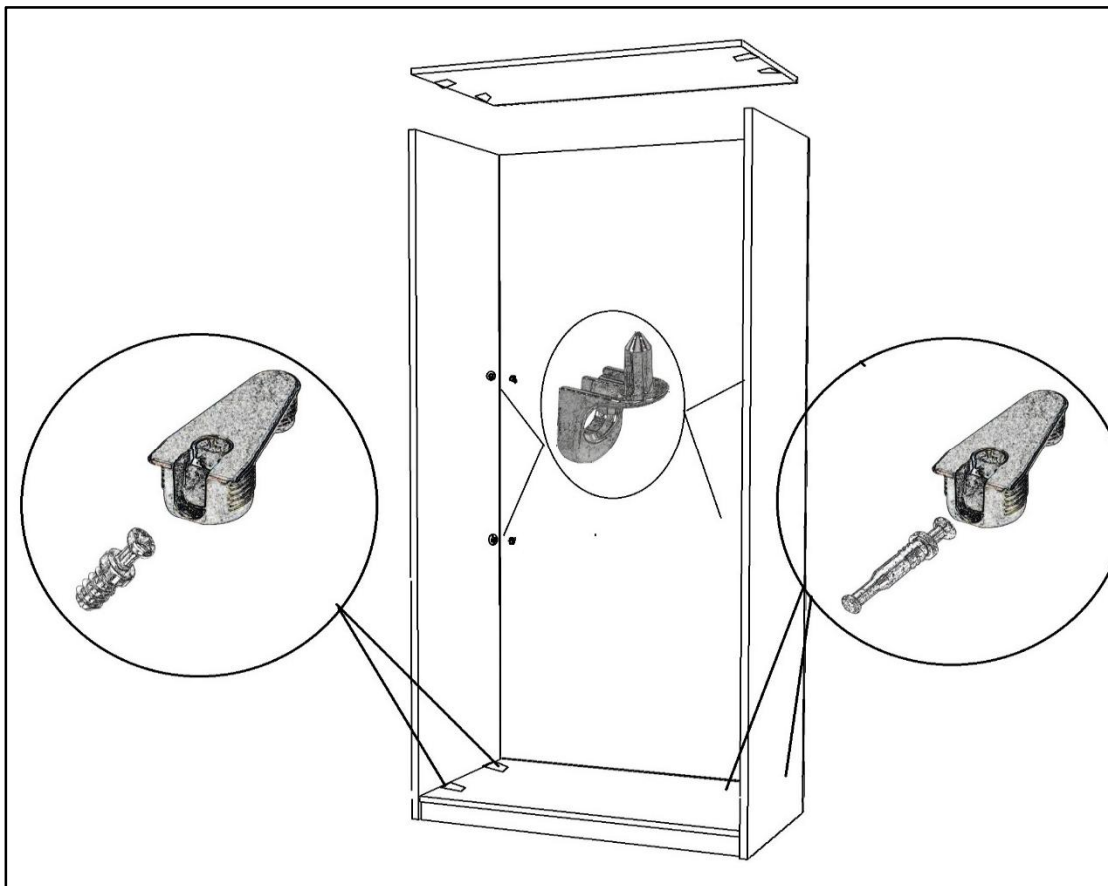

- 3** Postup montáže korpusu opakujeme.

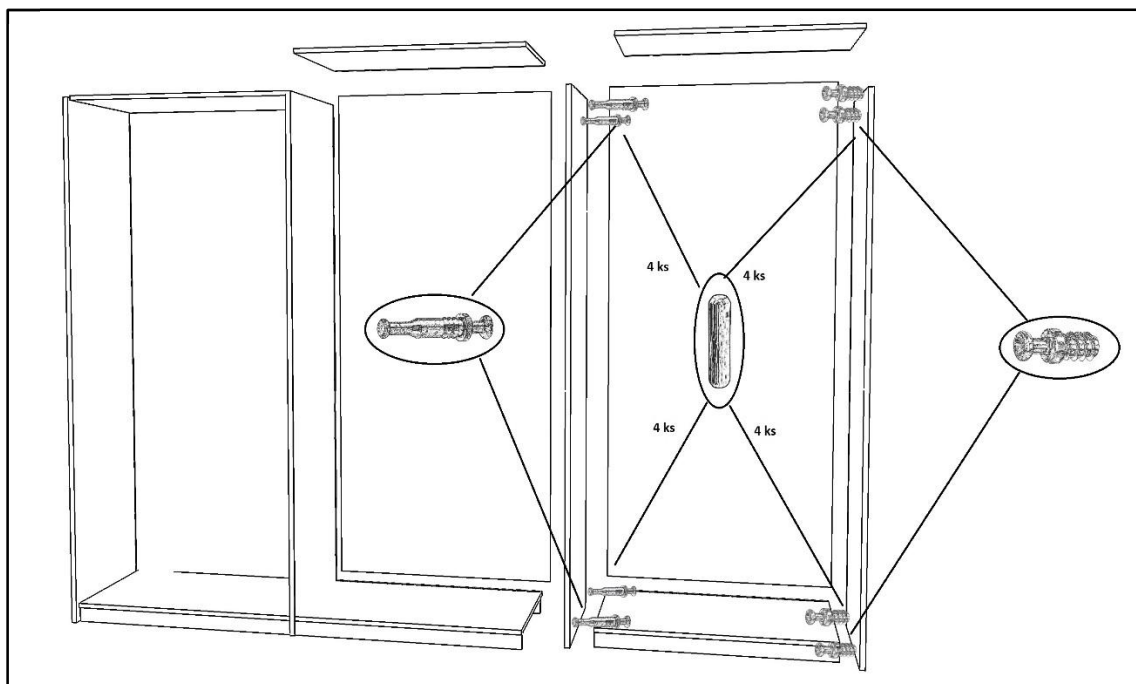

4 Do krajních dveří namontujeme NK záves naložený a do vnitřních dveří NK záves polonaložený.

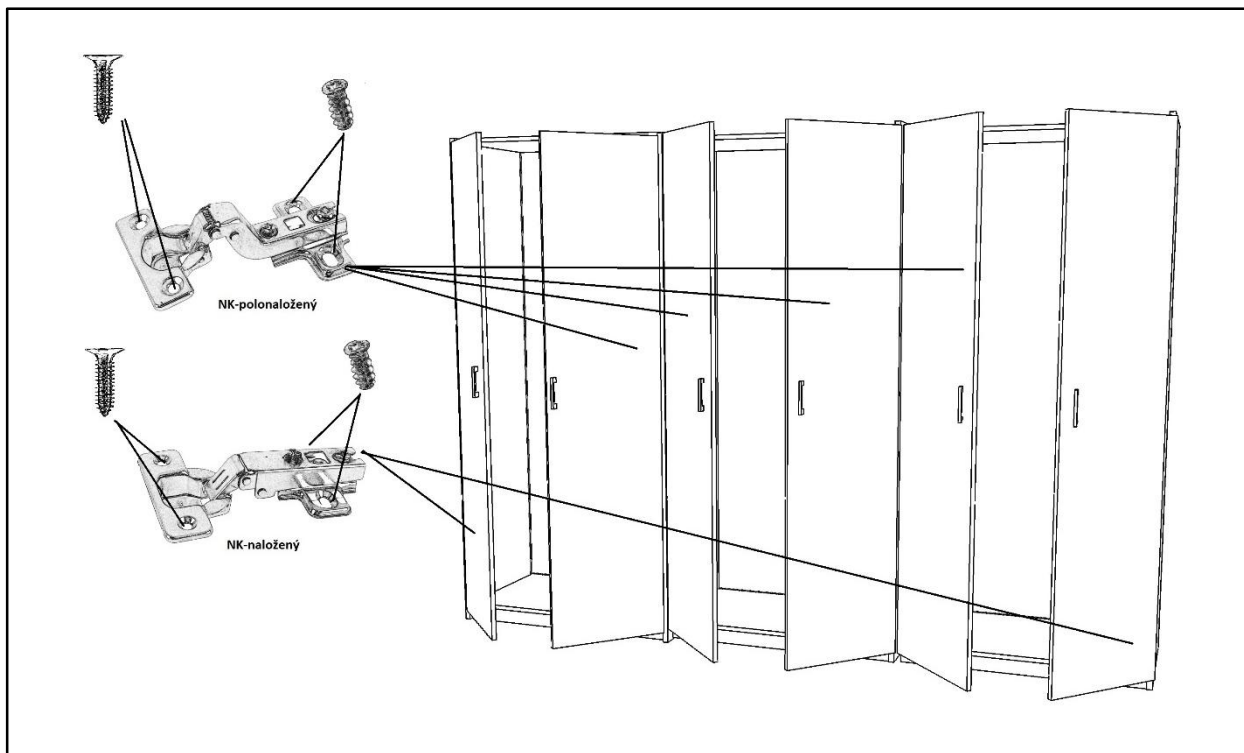
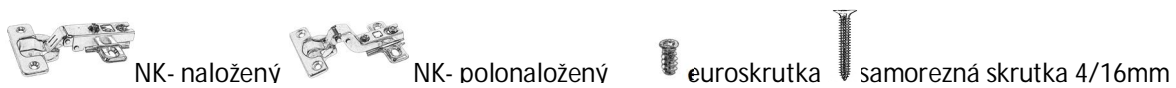

5 Pomocou samorezných skrutiek namontujeme okrasnú rampu skrine.

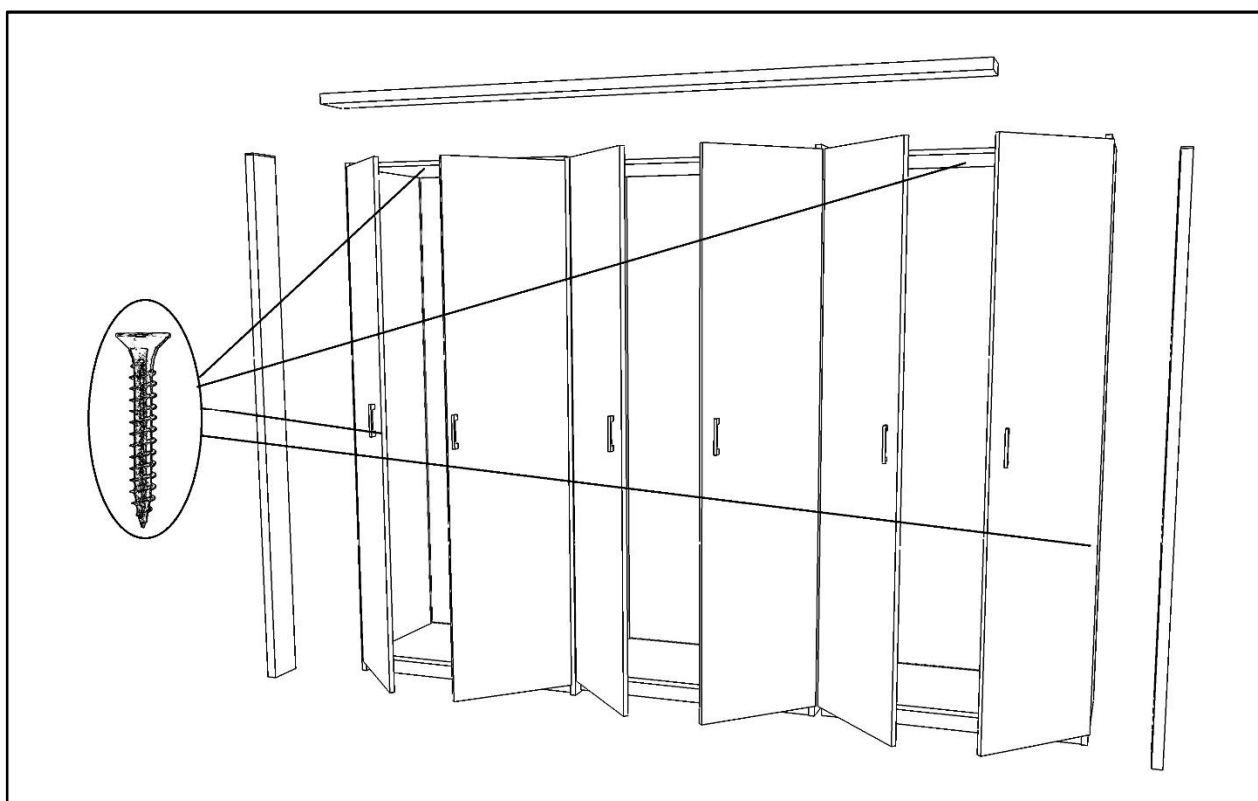
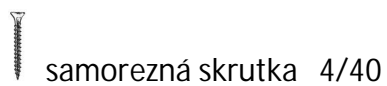

6 Na záver, nasadíme podperky políc do korpusu skrine, podpery tyče a namontujeme madlá na dvere .



podpera tyče









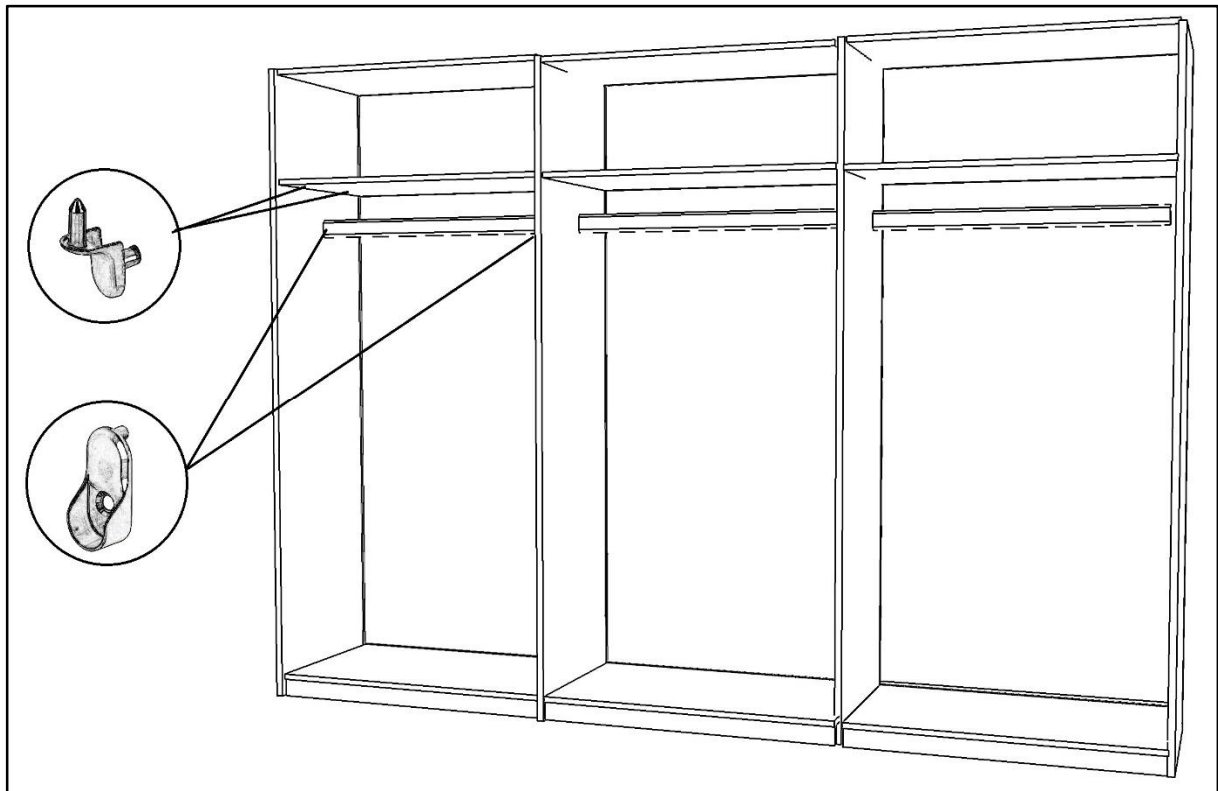



podperka police



↑ samorezná skrutka 3,5/16mm



Montážny balíček obsahuje:

	sam. skrutka 4/16 mm	60 ks		tiahlo jednostranné	8 ks
	sam. polgul. hlava skrutka 4/16	12 ks		samorezná skrutka 4/40	6 ks
	samorezná skrutka 3,5/20	12 ks		samorezná skrutka 3,5/16	12 ks
	NK- naložený	8 ks		drevený kolík	30 ks
	NK-polonaložený	16 ks		podpera tyče	6 ks
	podperka police	24 ks		spojka	12 ks
	euroskrutka	48 ks		tiahlo obojstranné	8 ks

Pozn: Pri jednotlivých rozmeroch sa môže obsah montážneho balíčka líšiť!